

# Data Sheet



Article number: 390215001044510

Description: Worm gear  
VF 150-F2-10-112B5, without lubrication

## Measures

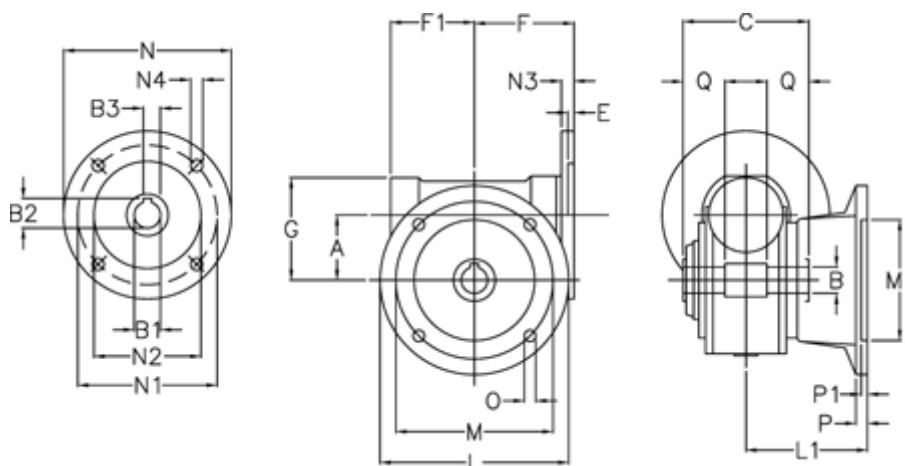

A	= 150	F1	= 179	N2	= 180
B	= 50 H7	G	= 218	N3	= 11
B1 E7	= 28	L	= 350	N4	= 13
B2	= 31.3	L1	= 220	O	= 18
B3 H9	= 8	M	= 290	P	= 22
C	= 175	M1	= 200	P1	= 20
E	= 2	N	= 250	Q	= 55
F	= 190	N1	= 215		